

FITINGURI DE COMPRESIUNE DIN PP

COT DE COMPRESIUNE 90°

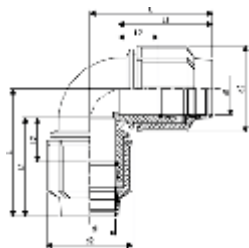

Cod articol	D (mm)	D1 (mm)	D2 (mm)	L (mm)	L1 (mm)	L2 (mm)	Ambalare (buc/cutie)
FEI0004	20	22	46	71	58	18	70
FEI0005	25	28	57	77	60	17	45
FEI0006	32	34	67	88	67	20	30
FEI0095	40	44	82	117	86	27	28
FEI0013	50	53	93	128	97	28	14
FEI0034	63	65	117	160	114	35	8
FEI0191	75	78	134	178	129	48	6
FEI0057	90	93	160	235	163	62	4
FEI0014	110	113	181	250	168	57	2

COT MIXT COMPRESIUNE 90° CU FILET INTERIOR (FI)

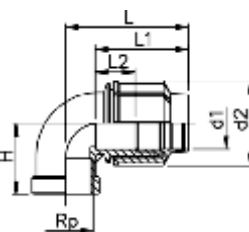

	D (mm)	Rp (inch)	D1 (mm)	D2 (mm)	L (mm)	L1 (mm)	L2 (mm)	H (mm)	Ambalare (buc/cutie)
FEI0020	20	1/2	22	46	71	58	18	50	100
FEI0412	20	3/4	22	46	71	58	18	50	200
FEI0413	25	1/2	28	57	77	60	18	53	65
FEI0053	25	3/4	28	57	77	60	18	53	65
FEI0309	32	3/4	34	67	87	68	22	60	100
FEI0025	32	1	34	67	87	68	22	60	40
FEI0088	40	1 1/4	44	82	120	87	27	53	36
FEI0026	50	1/2	53	93	130	97	28	62	20
FEI1044	50	2	53	93	130	97	28	75	35
FEI0036	63	2	65	117	160	114	35	70	12
FEI0358	75	2 1/2	78	134	178	129	48	75	8
FEI0312	90	3	93	160	235	163	62	100	7
FEI0059	110	4	113	181	250	168	57	116	4

COT MIXT COMPRESIUNE 90° CU FILET EXTERIOR (FE)

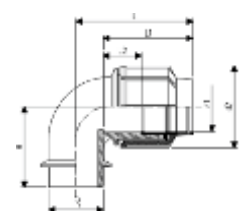

Cod articol	D (mm)	R (inch)	D1 (mm)	D2 (mm)	L (mm)	L1 (mm)	L2 (mm)	H (mm)	Ambalare (buc/cutie)
FEI0021	20	1/2	22	46	71	58	18	50	120
FEI1020	20	3/4	22	46	71	58	18	50	250
FEI0033	25	3/4	28	57	77	60	17	53	75
FEI0087	25	1	28	57	77	60	17	53	75
FEI0044	32	1	34	67	88	68	22	60	45
FEI0089	40	1 1/4	44	82	117	86	27	73	40
FEI0027	50	1 1/2	53	93	128	97	28	80	24
FEI0035	63	2	65	117	160	114	35	82	14

MUFĂ EGALĂ DE COMPRESIUNE

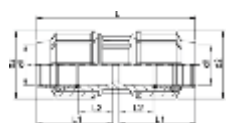

	D (mm)	D1 (mm)	D2 (mm)	L (mm)	L1 (mm)	L2 (mm)	Ambalare (buc/cutie)
FEI0023	20	22	46	114	55	14	90
FEI0113	25	28	57	124	62	17	60
FEI0128	32	34	67	136	65	18	36
FEI0129	40	44	80	176	86	27	36
FEI0130	50	54	93	195	96	27	18
FEI0070	63	65	115	248	122	42	11
FEI0153	75	78	134	278	136	54	8
FEI0132	90	93	164	336	167	61	3
FEI0038	110	113	186	381	190	71	5

MUFĂ MIXTĂ DE COMPRESIUNE CU FILET EXTERIOR (FE)



Cod articol	D (mm)	R (inch)	D1 (mm)	D2 (mm)	L (mm)	L1 (mm)	L2 (mm)	Ambalare (buc/cutie)
FEI0048	20	1/2	22	46	76	16	56	140
FEI0256	20	3/4	22	46	77	15	55	375
FEI0257	25	1/2	28	57	82	18	62	100
FEI0114	25	3/4	28	57	82	18	62	100
FEI0315	32	3/4	34	67	89	20	68	150
FEI0086	32	1	34	67	92	20	68	60
FEI0135	40	1 ^{1/4}	44	82	115	28	87	36
FEI0138	40	1 ^{1/2}	44	82	115	27	87	100
FEI0317	40	1	44	82	115	27	87	100
FEI0045	50	1 ^{1/2}	54	93	126	30	99	30
FEI0102	63	2	65	117	156	41	119	18
FEI0258	75	2 ^{1/2}	77	134	178	56	134	16
FEI0259	90	3	93	160	210	68	168	6
FEI0314	110	4	113	181	231	71	178	7

MUFĂ MIXTĂ DE COMPRESIUNE CU FILET INTERIOR (FI)

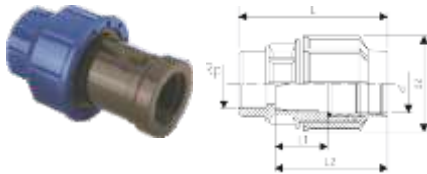

Cod articol	D (mm)	Rp (inch)	D1 (mm)	D2 (mm)	L (mm)	L1 (mm)	L2 (mm)	Ambalare (buc/cutie)
FEI0049	20	1/2	22	46	78	17	58	135
FEI0260	20	3/4	22	46	78	16	57	300
FEI0700	25	1/2	28	57	86	18	61	100
FEI0050	25	3/4	28	57	86	18	61	100
FEI0700	25	1	28	57	86	18	61	100
FEI0316	32	3/4	34	67	95	20	67	150
FEI0103	32	1	34	67	95	20	67	60
FEI1021	40	1 ^{1/4}	44	82	116	28	87	36
FEI0134	40	1/2	44	82	116	28	87	36
FEI0046	50	1/2	54	93	128	30	99	30
FEI1033	63	1/2	65	117	161	51	128	18
FEI0101	63	2	65	117	161	51	128	18
FEI0318	75	2 ^{1/2}	78	134	174	56	136	13
FEI0123	90	3	93	160	196	55	155	6
FEI0077	110	4	113	181	215	48	170	6

MUFĂ REDUSĂ DE COMPRESIUNE (REDUCȚIE)

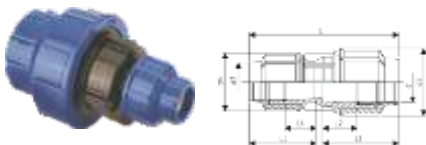

Cod articol	D-D (mm)	D1 (mm)	D2 (mm)	D3 (mm)	D4 (mm)	L (mm)	L1 (mm)	L2 (mm)	L3 (mm)	L4 (mm)	Ambalare (buc/cutie)
FEI0319	25-20	28	54	22	46	133	63	21	56	15	70
FEI0320	32-25	35	64	28	54	130	65	18	59	18	48
FEI0264	40-32	44	82	35	64	164	94	34	66	22	22
FEI0265	50-40	53	93	44	82	204	103	34	97	38	24
FEI0322	63-50	65	117	53	93	216	117	38	96	28	12
FEI0359	75-63	78	134	65	117	249	129	48	116	37	8
FEI0266	90-63	93	160	65	117	292	169	61	107	36	6
FEI0356	90-75	93	160	78	134	366	188	87	175	94	6
FEI0262	110-90	113	181	93	160	363	188	70	168	61	6

ADAPTOR DE FLANȘĂ PRIN COMPRESIUNE (CAPĂT DE FLANȘĂ)



Cod articol	D (mm)	DN (inch)	DN (mm)	D1 (mm)	D2 (mm)	D3 (mm)	D4 (mm)	L (mm)	L1 (mm)	L2 (mm)	Ambalare (buc/cutie)
FEI0324	50	1 ^{1/2}	40	M	93	150	110	170	36	100	1
FEI0147	63	2	50	65	117	174	125	193	48	126	1
FEI0075	75	2 ^{1/2}	65	78	134	185	145	197	104	185	8
FEI0056	90	3	80	93	160	200	160	232	65	166	5
FEI0579	90	3	100	93	160	200	160	232	65	166	5
FEI0052	110	4	100	113	181	220	181	239	107	220	4

DOP DE COMPRESIUNE

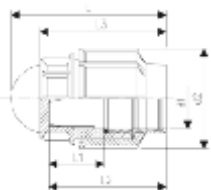

Cod articol	D (mm)	D1 (mm)	D2 (mm)	L (mm)	L1 (mm)	L2 (mm)	L3 (mm)	Ambalare (buc/cutie)
FEI20S0120	20	22	46	69	18	58	62	150
FEI25S0120	25	28	57	76	18	63	65	100
FEI32S0120	32	34	67	90	18	70	69	72
FEI40S0120	40	44	82	112	28	87	93	40
FEI50S0120	50	54	93	129	30	99	105	30
FEI63S0120	63	65	117	160	42	122	132	20
FEI75S0120	75	78	134	180	56	139	147	14
FEI90S0120	90	93	160	220	68	173	181	6
FEI10S0120	110	114	182	234	70	184	195	7

TEU EGAL DE COMPRESIUNE



Cod articol	D (mm)	D1 (mm)	D2 (mm)	L (mm)	L1 (mm)	L2 (mm)	H (mm)	Ambalare (buc/cutie)
FEI20T0020	20	22	46	138	55	13	55	48
FEI25T0025	25	28	57	153	60	18	77	30
FEI32T0032	32	34	67	175	66	20	87	30
FEI40T0040	40	44	82	238	88	27	118	18
FEI50T0050	50	53	93	259	96	28	128	8
FEI63T0063	63	65	117	317	113	35	160	6
FEI75T0075	75	78	134	360	129	48	180	3
FEI0192	90	93	160	472	183	82	140	2
FEI0039	110	113	181	512	193	80	260	1

TEU REDUS DE COMPRESIUNE

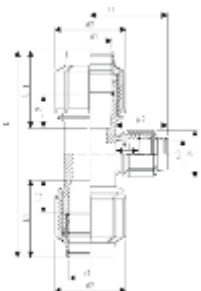

Cod articol	D-D-D (mm)	D1 (mm)	D2 (mm)	D3 (mm)	D4 (mm)	L (mm)	L1 (mm)	L2 (mm)	H1 (mm)	H2 (mm)	Ambalare (buc/cutie)
FEI25T0020	25-20-25	28	54	22	46	153	58	17	18	58	33
FEI0308	32-25-32	35	64	28	54	173	64	19	21	63	45
FEI40T0032	40-32-40	44	82	35	64	238	87	27	21	66	18
FEI50T0040	50-40-50	53	93	44	82	259	96	28	38	94	9
FEI63T0050	63-50-63	65	117	53	93	317	113	35	28	90	6
FEI75T0063	75-63-75	78	134	65	117	360	129	48	35	113	4

TEU MIXT DE COMPRESIUNE CU FILET EXTERIOR (FE)

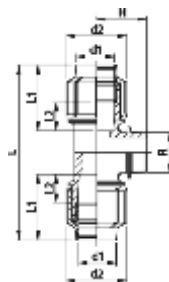

Cod articol	D (mm)	R (inch)	D1 (mm)	D2 (mm)	L (mm)	L1 (mm)	L2 (mm)	H (mm)	Ambalare (buc/cutie)
FEI20T0101	20	1/2	22	46	143	58	18	50	60
FEI25T0102	25	3/4	28	54	153	58	17	54	40
FEI32T0103	32	1	34	67	175	66	20	60	40
FEI40T0104	40	1 ^{1/4}	44	82	238	88	27	73	22
FEI50T0105	50	1 ^{1/2}	53	93	259	96	28	80	12
FEI63T0106	63	2	65	117	317	113	35	82	8
FEI75T0107	75	2 ^{1/2}	78	134	360	129	48	105	4

TEU REDUS DE COMPRESIUNE CU FILET INTERIOR (FI)

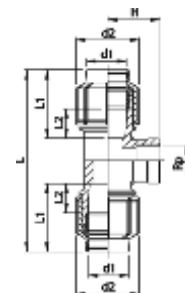

Cod articol	D (mm)	Rp (inch)	D1 (mm)	D2 (mm)	L (mm)	L1 (mm)	L2 (mm)	H (mm)	Ambalare (buc/cutie)
FEI20T0201	20	1/2	22	46	143	58	18	48	60
FEI25T0202	25	3/4	28	57	153	60	18	37	40
FEI32T0203	32	1	34	67	175	66	20	43	36
FEI40T0204	40	1 ^{1/4}	44	82	238	87	27	53	22
FEI50T0205	50	1 ^{1/2}	53	93	260	97	28	63	11
FEI63T0206	63	2	65	117	317	113	35	70	8
FEI75T0207	75	2 ^{1/2}	78	134	360	129	48	75	4
FEI0125	90	3	93	160	472	183	82	101	4
FEI0427	110	4	113	181	512	193	80	115	2

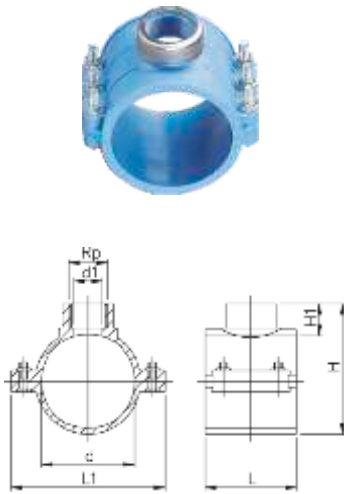
COLIER BRANȘARE DE COMPRESIUNE PN 16 - CU INEL RIGIDIZARE

Cod articol	D (mm)	Rp (inch)	B	M	D1 (mm)	L (mm)	L1 (mm)	H (mm)	H1 (mm)	Ambalare (buc/cutie)
FEI1107	25	3/4	2	M8X30	13	49	79	58	15	150
FEI1108	32	1/2	2	M8X30	14	49	79	62	20	150
FEI1109	32	3/4	2	M8X30	14	49	79	62	20	150
FEI0288	32	1	2	M8X40	14	62	87	70	20	100
FEI1110	40	1/2	2	M8X40	21	62	86	71	20	100
FEI1111	40	3/4	2	M8X40	21	62	86	71	20	100
FEI1112	40	1	2	M8X40	21	62	86	70	19	100
FEI1113	50	1/2	4	M8X40	21	62	86	82	20	100
FEI1114	50	3/4	4	M8X40	21	62	86	82	20	100
FEI1115	50	1	4	M8X40	21	62	86	82	20	100
FEI1025	50	1 ^{1/4}	4	M8X40	21	62	86	82	20	100
FEI1116	63	1/2	4	M8X40	18	62	101	96	21	70
FEI1117	63	3/4	4	M8X40	24	62	101	96	21	70
FEI1118	63	1	4	M8X40	31	62	101	96	21	70
FEI1119	63	1 ^{1/4}	4	M8X40	31	62	101	96	21	60
FEI1024	63	1 ^{1/2}	4	M8X40	31	62	101	96	21	60
FEI1120	75	1/2	4	M8X60	16	79	123	102	14	40
FEI1121	75	3/4	4	M8X60	21	79	123	104	16	40
FEI1122	75	1	4	M8X60	27	79	123	107	19	40
FEI1123	75	1 ^{1/4}	4	M8X60	35	79	123	109	21	40
FEI1124	75	1 ^{1/2}	4	M8X60	42	79	123	109	21	40
FEI1125	75	2	4	M8X60	53	79	123	112	24	40
FEI1126	90	1/2	4	M8X60	16	87	138	116	14	34
FEI1127	90	3/4	4	M8X60	21	87	138	118	16	34
FEI1128	90	1	4	M8X60	27	87	138	121	19	34
FEI1129	90	1 ^{1/4}	4	M8X60	35	87	138	123	21	34
FEI1130	90	1 ^{1/2}	4	M8X60	42	87	138	123	21	30
FEI1131	90	2	4	M8X60	53	87	138	126	24	30
FEI0271	110	1/2	6	M8X60	15	99	152	150	23	20
FEI0272	110	3/4	6	M8X50	20	99	152	150	23	20
FEI0105	110	1	6	M8X50	26	99	152	150	23	20
FEI0305	110	1 ^{1/4}	6	M8X50	35	99	152	150	23	20
FEI0304	110	1 ^{1/2}	6	M8X50	41	99	152	150	23	20
FEI0143	110	2	6	M8X50	51	99	152	150	23	20
FEI1029	110	3	6	M8X50	85	99	152	150	23	12
FEI0156	125	1/2	6	M8X70	15	101	166	169	24	20
FEI0273	125	3/4	6	M8X50	20	101	166	169	24	20
FEI0157	125	1	6	M8X50	26	101	166	169	24	20
FEI1059	125	1 ^{1/4}	6	M8X50	35	101	166	168	23	20
FEI1060	125	1 ^{1/2}	6	M8X50	41	101	166	168	23	20
FEI0158	125	2	6	M8X50	50	101	166	168	23	20
FEI0540	*125	3	6	M8X50	85	139	178	180	37	12
FEI0758	*125	4	6	M10X70	90	139	178	181	38	12
FEI0275	140	1/2	6	M10X70	18	114	207	191	25	20
FEI0277	140	3/4	6	M10X70	24	114	207	191	25	20
FEI0274	140	1	6	M10X70	30	114	207	191	25	20
FEI1030	140	1 ^{1/4}	6	M10X70	38	114	207	191	25	20
FEI1132	140	1 ^{1/2}	6	M10X70	45	114	207	191	24	20
FEI0276	140	2	6	M10X70	50	114	207	191	24	20
FEI0541	140	3	6	M10X70	85	142	208	201	38	10
FEI0750	140	4	6	M10X70	90	142	208	201	38	10
FEI0543	160	1/2	6	M10X70	18	114	226	215	24	20
FEI0281	160	3/4	6	M10X70	24	114	226	215	24	20
FEI0279	160	1	6	M10X70	30	114	226	215	24	20
FEI0278	160	1 ^{1/4}	6	M10X70	37	114	226	215	24	20
FEI0542	160	1 ^{1/2}	6	M10X70	45	114	226	215	24	20
FEI0280	160	2	6	M10X70	51	114	226	215	24	20
FEI0544	160	3	6	M10X70	84	142	228	222	24	10
FEI0545	160	4	6	M10X70	90	142	228	222	24	10
FEI1031	180	1	6	M10x80	30	169	262	265	38	7
FEI1042	180	1 ^{1/4}	6	M10x80	36	169	262	265	38	7
FEI0155	180	1 ^{1/2}	6	M10x80	42	169	262	265	38	7
FEI0808	180	2	6	M10x80	54	169	262	265	38	7
FEI1032	180	3	6	M10x80	84	169	262	265	38	7
FEI0719	180	4	6	M10x80	108	169	262	265	38	7
FEI0282	200	1 ^{1/2}	6	M10x80	45	169	262	265	38	8
FEI0154	200	2	6	M10x80	54	169	262	265	38	7
FEI0547	200	3	6	M10x80	85	169	262	265	38	7
FEI0692	200	4	6	M10x80	103	169	262	267	40	7
FEI0284	225	1 ^{1/2}	6	M10x80	45	145	287	287	26	5

* - prevăzut cu garnitură tip O-ring - PN6



Cod articol	D (mm)	Rp (inch)	B	M	D1 (mm)	L (mm)	L1 (mm)	H (mm)	H1 (mm)	Ambalare (buc/cutie)
FEI0283	225	2	6	M10x80	51	145	287	287	26	5
FEI0408	225	3	6	M10x80	85	174	287	295	37	5
FEI0548	225	4	6	M10x80	103	174	287	295	38	5
FEI0311	250	2	6	M10x80	55	178	310	314	38	5
FEI0549	250	3	6	M10x80	85	178	310	314	38	5
FEI0350	250	4	6	M10x80	103	178	310	314	38	5
FEI0285	280	2	6	M10x80	51	179	335	326	31	3
FEI0286	280	3	6	M10x80	78	179	335	338	41	3
FEI1041	280	4	6	M10x80	98	179	335	338	46	3
FEI0287	315	2	6	M10x120	51	246	390	350	31	3
FEI0551	315	3	6	M10x120	78	246	390	363	41	3
FEI0552	315	4	6	M10x120	98	246	390	363	46	3

COLIER BRANȘARE DE COMPRESIUNE PN 12,5 - FĂRĂ INEL RIGIDIZARE



Cod articol	D (mm)	Rp (inch)	B	M	D1 (mm)	L (mm)	L1 (mm)	H (mm)	H1 (mm)	Ambalare (buc/cutie)
FEI0140	25	1/2	2	M8X30	13	49	79	58	15	150
FEI1088	25	3/4	2	M8X30	13	49	79	58	15	150
FEI0659	32	1/2	2	M8X30	14	49	79	62	20	150
FEI0660	32	3/4	2	M8X30	14	49	79	62	20	150
FEI0534	32	1	2	M8X30	14	62	87	70	20	100
FEI0289	40	1/2	2	M8X40	21	62	86	71	20	100
FEI0564	40	3/4	2	M8X40	21	62	86	71	20	100
FEI0111	40	1	2	M8X40	21	62	86	70	19	100
FEI0349	50	1/2	2	M8X40	21	62	86	82	20	100
FEI0110	50	3/4	2	M8X40	21	62	86	82	20	100
FEI0109	50	1	2	M8X40	21	62	86	82	20	100
FEI0535	50	1 ^{1/4}	2	M8X40	21	62	86	82	20	100
FEI0612	63	1/2	4	M8X40	18	62	101	96	21	70
FEI0108	63	3/4	4	M8X40	24	62	101	96	21	70
FEI0107	63	1	4	M8X40	31	62	101	96	21	70
FEI0292	63	1 ^{1/4}	4	M8X40	31	62	101	96	21	60
FEI0291	63	1 ^{1/2}	4	M8X40	31	62	101	96	21	60
FEI0539	75	1/2	4	M8X70	16	79	123	102	14	40
FEI0295	75	3/4	4	M8X70	21	79	123	104	16	40
FEI0293	75	1	4	M8X70	27	79	123	107	19	40
FEI0538	75	1 ^{1/4}	4	M8X70	35	79	123	109	21	40
FEI0537	75	1 ^{1/2}	4	M8X70	42	79	123	109	21	40
FEI0141	75	2	4	M8X70	53	79	123	112	24	40
FEI0297	90	1/2	4	M8X70	16	87	138	116	14	34
FEI0142	90	3/4	4	M8X70	21	87	138	118	16	34
FEI0106	90	1	4	M8X70	27	87	138	121	19	34
FEI0407	90	1 ^{1/4}	4	M8X70	35	87	138	123	21	30
FEI0296	90	1 ^{1/2}	4	M8X70	42	87	138	123	21	34
FEI0150	90	2	4	M8X70	53	87	138	126	24	30
FEI0306	110	1/2	4	M8X50	15	99	152	150	23	20
FEI0714	110	3/4	4	M8X50	20	99	152	150	23	20
FEI0310	110	1	4	M8X50	26	99	152	150	23	20
FEI0683	110	1 ^{1/4}	4	M8X50	35	99	152	150	23	20
FEI0614	110	1 ^{1/2}	4	M8X50	41	99	152	150	23	20
FEI0613	110	2	4	M8X50	51	99	152	150	23	20
FEI1089	125	1/2	4	M8X50	15	101	166	169	24	20
FEI1090	125	3/4	4	M8X50	20	101	166	169	24	20
FEI1091	125	1	4	M8X50	26	101	166	169	24	20
FEI1093	125	1 ^{1/4}	4	M8X50	35	101	166	168	23	20
FEI1092	125	1 ^{1/2}	4	M8X50	41	101	166	168	23	20
FEI1094	125	2	4	M8X50	50	101	166	168	23	20
FEI1095	140	1/2	4	M8X70	18	114	207	191	25	20
FEI1096	140	3/4	4	M8X70	24	114	207	190	24	20
FEI1097	140	1	4	M8X70	30	114	207	190	24	20
FEI1099	140	1 ^{1/4}	4	M8X70	38	114	207	190	24	20
FEI1098	140	1 ^{1/2}	4	M8X70	45	114	207	189	23	20
FEI1100	140	2	4	M8X70	50	114	207	190	24	20
FEI1101	160	1/2	4	M8X70	18	114	226	215	24	20
FEI1102	160	3/4	4	M8X70	24	114	226	215	24	20
FEI1103	160	1	4	M8X70	30	114	226	215	24	20
FEI1105	160	1 ^{1/4}	4	M8X70	37	114	226	215	24	20
FEI1104	160	1 ^{1/2}	4	M8X70	45	114	226	215	24	20
FEI1106	160	2	4	M8X70	50	114	226	215	24	20

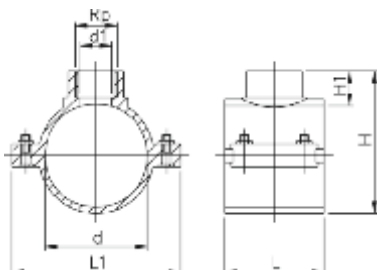

TEU DE BRANȘAMENT COMPRESIUNE BRANȘAREA ÎN PRESIUNE A ȚEVILOR DE PE-680C-PE LINE

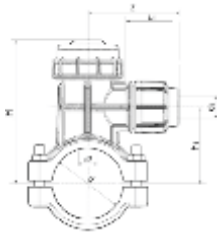

L - lungime
B - nr. șuruburi

Cod articol	D (mm)	D1 (mm)	D2 (mm)	B	M	L (mm)	L1 (mm)	H (mm)	H1 (mm)	Z (mm)
FEI1133	50	20	26	4	M8X50	75	55	118	58	80
FEI1134	50	25	26	4	M8x50	75	58	118	58	90
FEI1135	50	32	26	4	M8X50	75	64	118	58	100
FEI1136	63	20	26	4	M8X50	90	55	125	65	80
FEI1137	63	25	26	4	M8X50	90	60	125	65	90
FEI1138	63	32	26	4	M8X50	90	63	125	65	100
FEI1139	75	25	33	4	M8X70	98	60	142	75	90
FEI1140	75	32	33	4	M8X70	98	62	142	75	100
FEI1141	75	40	33	4	M8X70	98	74	142	75	120
FEI1142	90	25	33	4	M8X70	100	60	152	85	90
FEI1143	90	32	33	4	M8X70	100	62	152	85	100
FEI1144	90	40	33	4	M8X70	100	74	152	85	120
FEI1145	110	25	33	6	M8X70	130	60	190	108	100
FEI1146	110	32	33	6	M8X70	130	77	190	108	118
FEI1147	110	40	33	6	M8X70	130	87	190	118	130
FEI1148	110	50	40	6	M8X70	130	108	205	118	151
FEI1149	110	63	40	6	M8X70	130	125	205	118	180
FEI1150	110	75	40	6	M8X70	130	146	205	118	205
FEI1151	125	32	40	6	M8X70	135	76	210	115	120
FEI1152	125	40	40	6	M8X70	135	87	210	115	130
FEI1153	125	50	40	6	M8X70	135	102	225	130	146
FEI1154	125	63	40	6	M8X70	135	128	225	130	180
FEI1155	125	75	40	6	M8X70	135	146	225	130	205
FEI1156	140	32	40	6	M10X100	155	72	225	125	120
FEI1157	140	40	40	6	M10X100	155	87	225	125	130
FEI1158	140	50	40	6	M10X100	155	102	240	135	146
FEI1159	140	63	40	6	M10X100	155	128	240	135	180
FEI1160	140	75	40	6	M10X100	155	146	240	135	205
FEI1161	160	32	40	6	M10X110	160	76	235	140	120
FEI1162	160	40	40	6	M10X110	160	87	235	140	130
FEI1163	160	50	40	6	M10X110	160	110	250	155	146
FEI1164	160	63	40	6	M10X110	160	128	250	155	180
FEI1165	160	75	40	6	M10X110	160	146	250	155	205

TEU DE BRANȘAMENT COMPRESIUNE CU FILET INTERIOR BRANȘAREA ÎN PRESIUNE A ȚEVILOR DE PE-680F-PE LINE

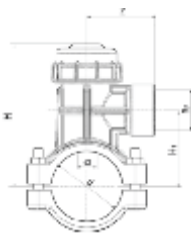

L - lungime
B - nr. șuruburi

Cod articol	D (mm)	Rp (inch)	D2 (mm)	B	M	D2 (mm)	L (mm)	H (mm)	H1 (mm)	Z (mm)
FEI1166	50	1	26	4	M8x50	26	75	118	58	61
FEI1167	63	1	26	4	M8x50	26	90	125	65	61
FEI1168	75	1	33	4	M8x70	33	98	142	75	61
FEI1169	90	1	33	4	M8x70	33	100	152	85	61
FEI1170	90	2	33	4	M8x70	33	100	152	85	72
FEI1171	110	1	33	6	M8x70	33	130	190	108	78
FEI1172	110	2	40	6	M8x70	40	130	205	118	80
FEI1173	125	2	40	6	M8x70	40	135	225	130	80
FEI1174	140	2	40	6	M10X100	40	155	240	135	80
FEI1175	160	2	40	6	M10X110	40	160	250	155	80

TEU DE BRANȘAMENT COMPRESIUNE CU FILET INTERIOR - BRANȘAREA ÎN PRESIUNE PENTRU ȚEVI DIN PE ȘI PVC-684F-CU ȘURUBURI ȘI PIULIȚE

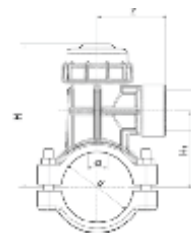

L - lungime
B - nr. șuruburi

Cod articol	D (mm)	Rp (inch)	D2 (mm)	B	M	D2 (mm)	L (mm)	H (mm)	H1 (mm)	Z (mm)
FEI1176	50	1	26	4	M8X50	26	75	118	58	61
FEI1177	63	1	26	4	M8X50	26	90	125	65	61
FEI1178	75	1	33	4	M8X70	33	98	142	75	61
FEI1179	90	1	33	4	M8X50	33	100	152	85	61
FEI1180	90	2	33	4	M8X50	33	100	152	85	72
FEI1181	110	1	33	6	M8X50	33	130	190	108	78
FEI1182	110	2	40	6	M8X50	40	130	205	118	80
FEI1183	125	2	40	6	M8X50	40	135	225	130	80
FEI1184	140	2	40	6	M10X100	40	155	240	135	80
FEI1185	160	2	40	6	M10X100	40	160	250	155	80